

Goodrive5000

Series High Performance Medium Voltage Vector Control VFDs

Your Trusted Industry Automation Solution Provider

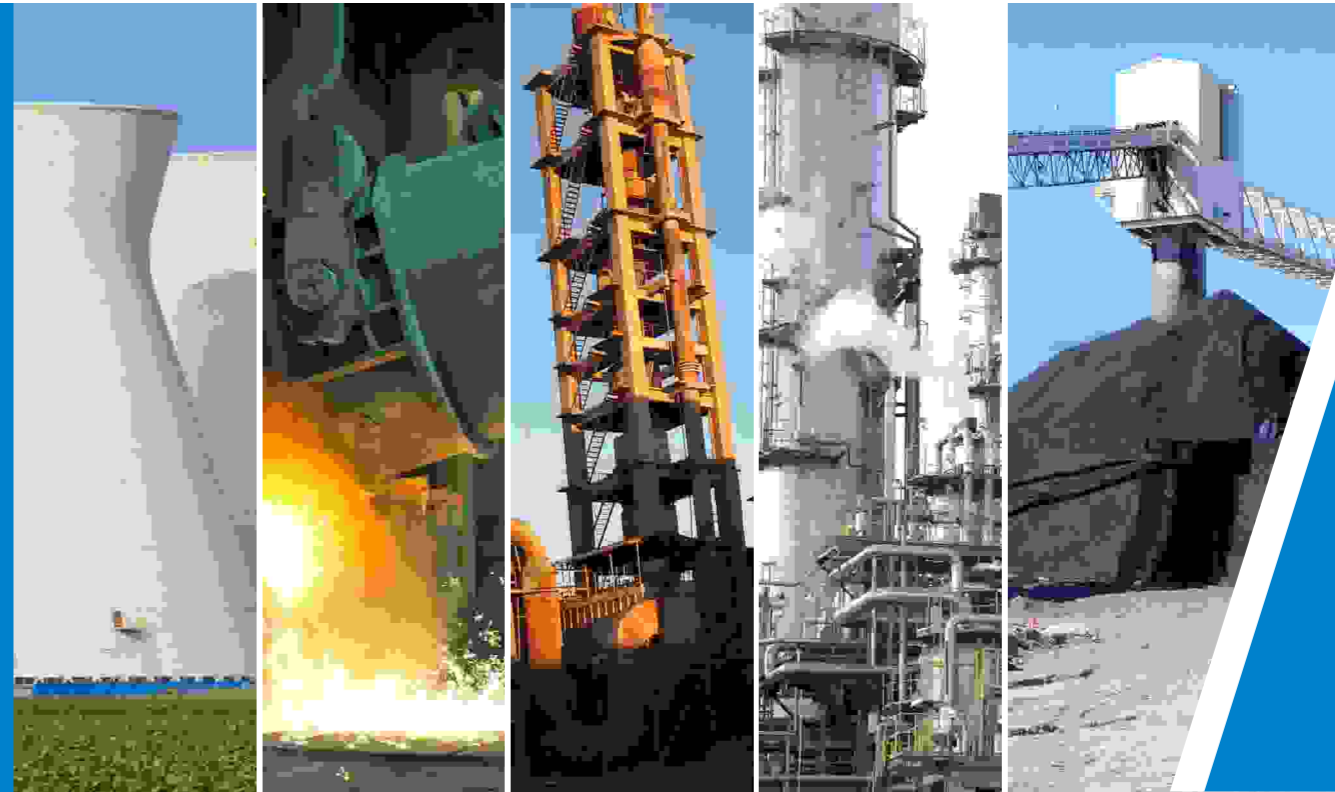

Service line:86-755-23535967 E-mail:overseas@invt.com.cn Website:www.invt.com

SHENZHEN INVT ELECTRIC CO., LTD.

INVT Guangming Technology Building, Songbai Road, Matian, Guangming District, Shenzhen, China

- | | | | | |
|-------------------------------|--|---------------------------------------|----------------------------|-----------------------------------|
| Industrial Automation: | • Variable-Frequency Drive | • Servo & Motion Control | • Motor & Electric Spindle | • PLC |
| | • HMI | • Intelligent Elevator Control System | • Traction Drive | |
| Electric Power: | • SVG | • Solar Pump Controller | • UPS | • Online Energy Management System |
| | • New Energy Vehicle Electric Control System | | | |

INVT Copyright.
Information may be subject to change without notice during product improving.

66003-00071 Y9/1-07(V1.0)



ABOUT INVT

INVT, founded in 2002, dedicates to being the globally leading and respected provider for products and services of industrial automation and electric power, and listed in A shares of Shenzhen Stock Exchange, stock code: 002334. INVT is one key high-tech enterprise of national torch project, which currently owns 11 holding subsidiaries, with key technologies of electric and electronic, automation, motor control, energy saving and environment protection, logistics network and informatization etc, and main products including high, medium and low voltage VFD, elevator intelligent integrated machine, servo, PLC, HMI, motor and electric principal axis, SVG, UPS and photovoltaic VFD etc. Currently, INVT has more than 1600 employees and 4 large-scale production bases, and its marketing network spreads all over more than 60 countries and regions home and abroad. INVT holds trying bests to provide the products and services beyond their prices and let the customers become more competitive as mission, and takes initiatives to explore the requirements of the customers. There are 9 R&D centers distributed all over the country, with many technologies in electric drive, industrial control and new energy fields reaching the first-class standards domestically and internationally, and more than 310 various patents, making INVT be capable of providing the most suitable products and solutions for the users to satisfy their requirements in terms of high-efficiency, energy saving, environment protection and total cost control etc. High quality, continuously renovating technology and excellent services make the reputation of INVT deep-rooted in people's hearts. Insights to the market and the grasp to the requirements make INVT maintain the innovation and flexibility of the products; advanced integrated product development and management, comprehensive product R&D testing and automation, informatization production guarantee INVT own the high reliability, performance and efficiency of the products; the branches distributed all around the world can provide professional guarantee of the solutions, technology training and service support for the users. Refined quality, wonderful value is brand promotion of INVT, which aims at better indicating that INVT's pursuit to refined quality and create maximum value for the customers. In the future decade, INVT will continue to inherit operating "conception of public sincerity and good virtue, realizing ambition with refined working", focus on core fields, stand on the technologies including electric and electronic, automation and motor control, and grow bigger and stronger in electric drive, industrial control and new energy fields, implement brand strategies, seek global development, cooperate with the people at all circles, construct industrial group with harmonious enterprise environment, and sufficiently share social responsibility.

About INVT.....	01
Product introduction.....	02
Product family tree.....	03
Applications	04
Product structure.....	05
Product feature.....	06
Technical parameters.....	10
Standard terminals.....	11
Model instruction.....	11
Dimension instruction.....	12
Two-quadrant topology.....	12
Two-quadrant selection table.....	13
Four-quadrant topology.....	18
Four-quadrant selection table.....	19
List of options and parts.....	20
Domestic applications	21
Overseas sales and service network.....	33

Product introduction

Goodrive5000 series products are medium voltage variable frequency speed control systems developed, designed and manufactured by INVT, adopt the most popular serial topology of power units and integrate DSP+FPGA+ARM 3-core control technology. With the most advanced high-performance vector control algorithm and compatible with vectorization VF control, the system applies to asynchronous and synchronous (PMS) motors and it is widely used in fans, pumps, compressors, belt conveyors, hoists, etc.



Product family tree

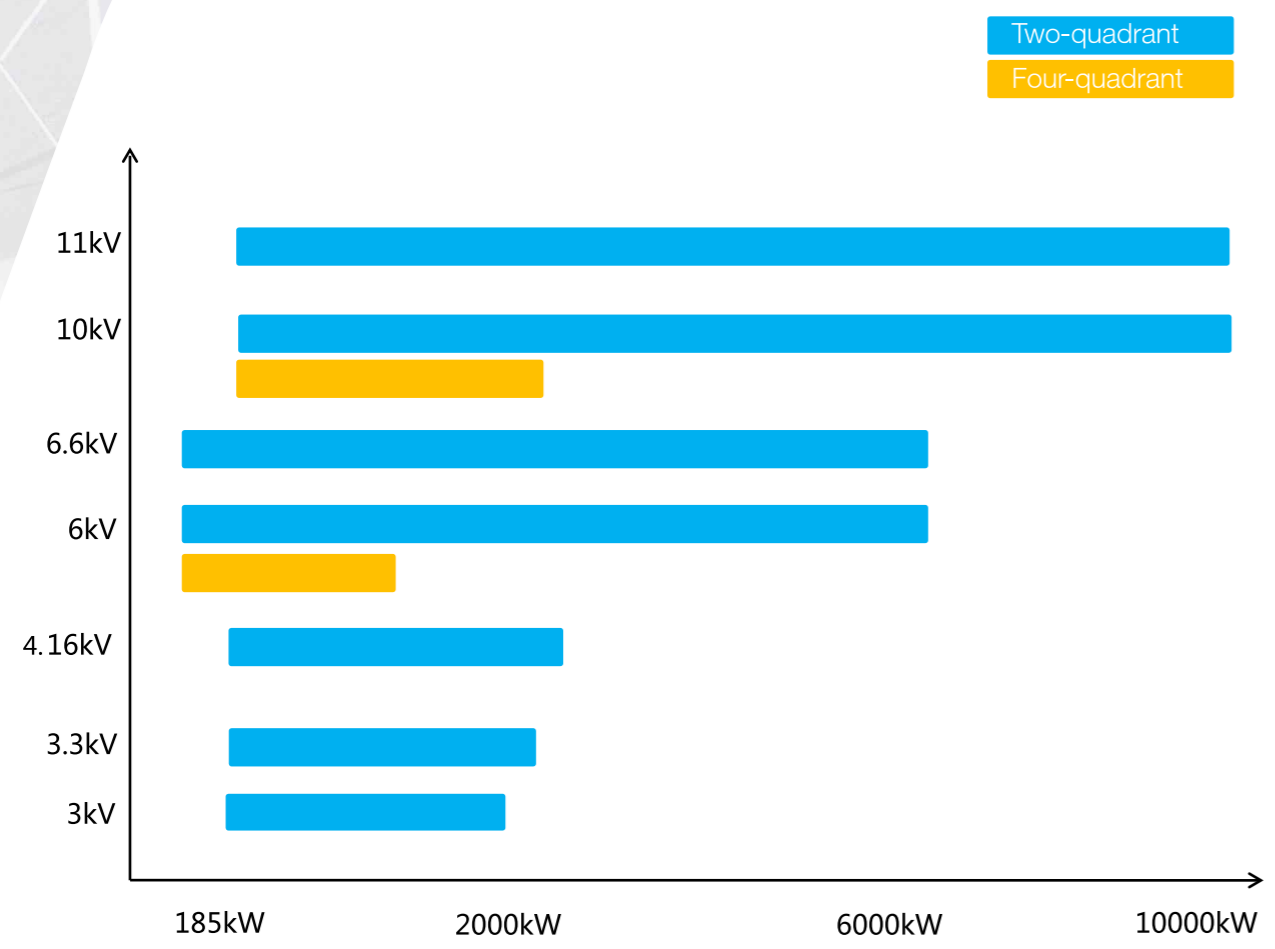

Applications

<p>Power</p> <p>ID (induced draft) fan, FD (forced draught) fan, primary fan, secondary fan, feed water pump, circulating pump, condensate pump, mortar pump</p>	<p>Mining</p> <p>Main ventilator, forcing fan, exhaust fan, air compressor, gas drainage pump, medium pump, draining pump, belt conveyor, roller press, primary and secondary mine hoist</p>
<p>Metallurgy</p> <p>Sintering main drawing fan, blast furnace blower, dusting blower, sulfur dioxide blower, ring cooling fan, combustion fan, circulating pump, slag washing pump, dephosphorization pump, chemical liquid pump, slurry pump, roller</p>	<p>Oil and gas</p> <p>Fuel supply pump, water injection pump, electric submersible pump, LNG pressure pump</p>
<p>Cement</p> <p>High temperature fan, exhaust fan at furnace head, exhaust fan at furnace end, coal mill circulating fan, raw mill circulating fan, cement mill circulating fan, ball mill fan</p>	<p>Municipal Engineering</p> <p>Clean water pump, sewage pump, purifying pump, mixed-flow pump, oxygen blower</p>
<p>Chemical Industry</p> <p>Dusting blower, gas blower, roots blower, sweetening fan, gas compressor (ammonia, CO2 and nitrogen), circulating pump</p>	<p>Others</p> <p>Pharmacy, paper making: fan, water pump Sugar industry: feeder, presser Rubber and plastic industry: internal mixer</p>

Product structure



Product feature

1 Three control modes

High performance VF

Support various control curves via motor control mode

Open loop vector

High precision control mode, no need to install speed sensor

Close loop vector

Ultra-high precision control mode, compatible with various types of encoders

2 Multiple types of motor drives

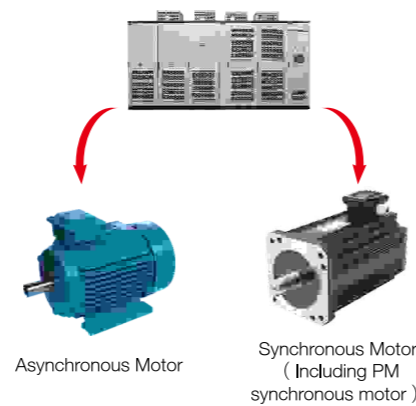

3 Four-quadrant drive

The power units use IGBT for rectification, dual energy flow, energy saving and environmental protection. With full power energy feedback capability.

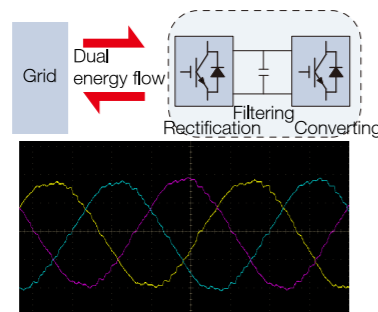

4 LVRT low voltage ride through

Wide voltage anti-interference capability. The system has AVR (automatic voltage regulation) function for stable system output when the bus voltage fluctuates frequently.

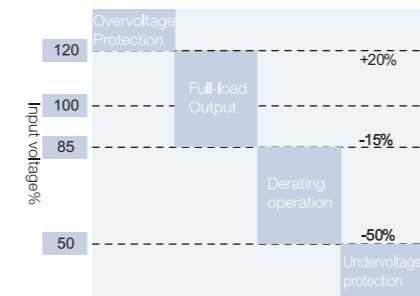

- No stop when instantaneous power off. During running, the system will not stop after power off in the set time. It can be set when power off 0~5s.

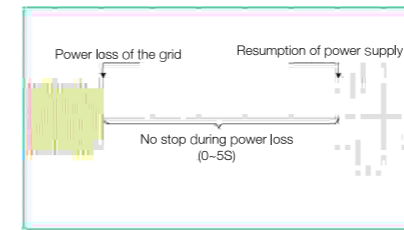

5 Full band rotating speed tracking

- Accurate tracking in the current rotating speed and direction of the motor without installing speed sensor
- Automatic starting when power off in the set time

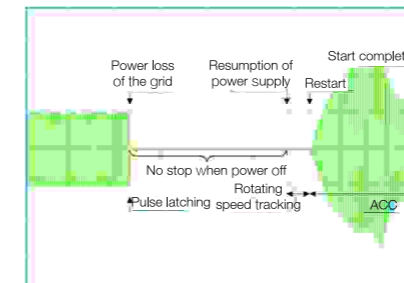

6 Unit bypass

- The same level bypass. When one unit is invalid, bypass it and derate to run.

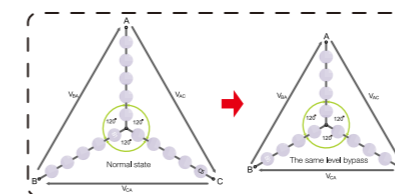

- Neutral point drifting bypass. Medium voltage output capability and strong on-site adaptability

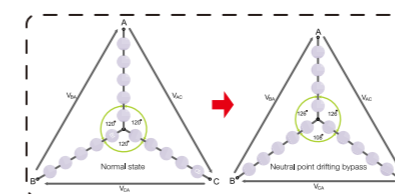

- Besides electronic bypass, unit bypass can apply mechanical bypass of contactors.

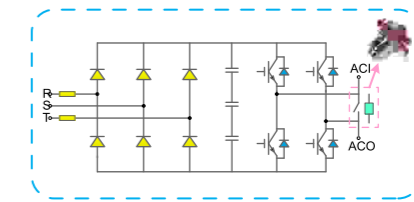

7 Excellent low frequency control

- Advanced dead area compensation technology, good low frequency waveforms; optimized algorithm of low frequency oscillation suppression, no motor resonance

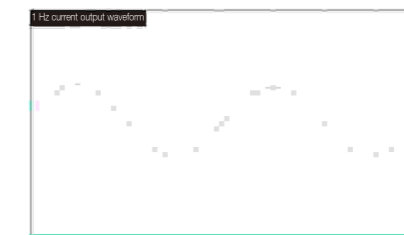

8 Excellent braking performance

- Flux braking. Apply to the cases requiring accurate stopping or when the load rotates irregularly before starting due to external factors.

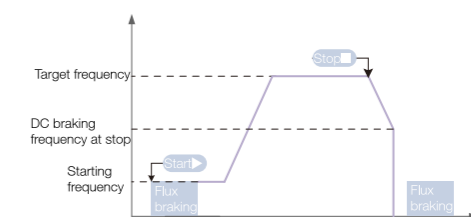

- Dual-frequency braking. Generate large braking torque, greatly shorten stopping time and apply to the cases with a high requirement on braking time.

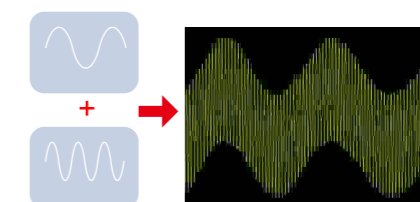

9 Master-slave control

- Multi-motor drive system. Realize multi-motor coordination control and obtain power balance.

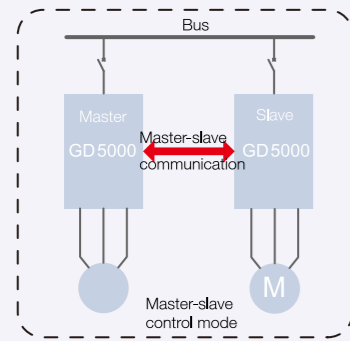

- Flexible/rigid connection

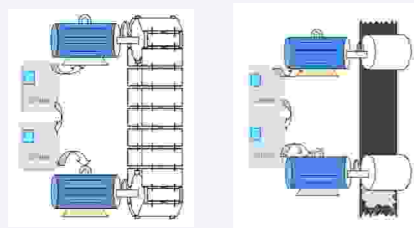

- Optical loop connection. Support 16 motors at most for master-slave control and the master can be set flexibly according to on-site conditions

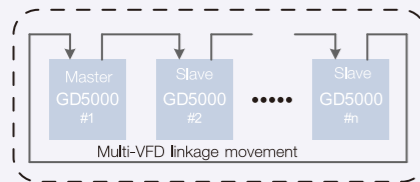

10 Bumpless synchronous switching

- By frequency-phase locking control, realize smooth switching without impact between variable frequency and power frequency.
- Apply to one-drive-more and soft start of the motor with large capacity.

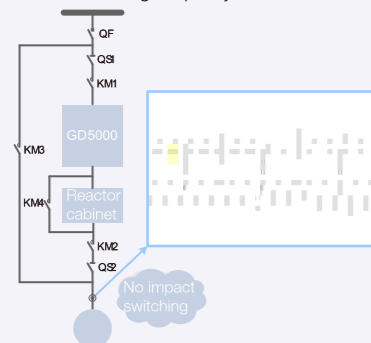

11 Upper computer monitoring software

- Goodrive5000 Series VFDs are configured with corresponding upper computer monitoring software, which can set and monitor the parameters of the VFD via upper computer; the user-friendly HMI is convenient for operation.

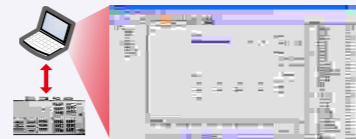

12 Rich bus interfaces

- Various communication protocols including ModBus-RTU, ProfiBus-DP and UDP/IP. Facilitate connecting with user DCS system and realize centralized monitoring and management on devices.

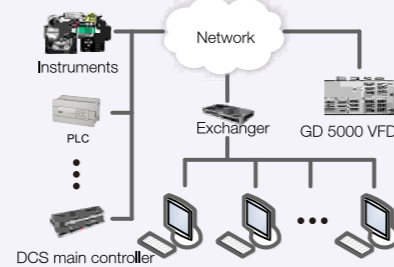

Technical parameters

Item		Two-quadrant parameters						Four-quadrant parameters		
Input	Voltage degree	AC 3PH						AC 3PH		
	Voltage fluctuation range	3kV	3.3kV	4.16kV	6kV	6.6kV	10kV	11kV	6kV	10kV
	Frequency	50/60Hz; ±5%								
	Power factor	≥0.97 (full load)								
	System efficiency	≥96% (full load)								
	Current harmonic	≤4%			≤2%			≤4%		
Output	Voltage range	0~rated input voltage								
	Frequency range	0~120Hz (customized)								
	Current harmonic	≤4%			≤2%			≤2%		
Control feature	Control mode	V/F control; sensorless vector control (SVC); vector control (VC)								
	Speed ratio	1:50 (VF); 1:100 (SVC); 1:200 (VC)								
	Speed control precision	±1% (VF); ±0.4% (SVC); ±0.2% (VC)								
	Torque response time	<200ms (SVC); <100ms (VC)								
	Starting torque	0.5Hz 150% of the rated torque (SVC); 0Hz 180% of the rated torque (VC)								
	Overload protection	120%: 120s; 150%: 5s; 200%: protect immediately								
Signal I/O	ACC/DEC time	0-3600s, customized								
	Digital input	8 channels digital input (extensible, programmable)								
	Digital output	8 channels relay output								
	Analog input	3 channels: AI1, AI2: 0~10V/0~20mA; AI3: -10V~10V								
	Analog output	4 channels: AO1, AO2, AO3, AO4: 0~10V/0~20mA								
	High speed pulse input	1 channel: input range: 0~50kHz								
Protection function	High speed pulse output	1 channel: output range: 0~50kHz								
	System	Overcurrent, overvoltage, undervoltage, motor overload, VFD overload, phase loss, overheating, temperature controller fault, access fault, communication fault								
	Unit	Undervoltage, overvoltage, power supply overheating, input phase loss, VCE fault, power supply fault, communication fault, bypass failure								
	HMI	Touch screen								
	Communication mode	Support Modbus protocol (RS485 interface), Profibus and Ethernet								
	Installation method	Cabinet mounting								
Others	Protection degree	IP30								
	Noise degree	≤75dB								
	Feed in and out method	Bottom in and out; other methods are optional								
	Cooling	Forced-air cooling								
	Control power supply	AC 380V±10%								
	MTBF	50000h								
Temperature of running environment	-5℃~+50℃, derate 1.5% for every additional 1℃ if the temperature is above 50℃ and the maximum temperature is 55℃; run without load if the temperature reaches 60℃.									
Altitude	Below 1000m; derate 1% for every additional 100m if the sea level is above 1000m									
Storage	Keep away from dust, direct sunlight, flammable or corrosive gas, oil, steam and vibration									
Vibration	0.59g below									

Standard terminals

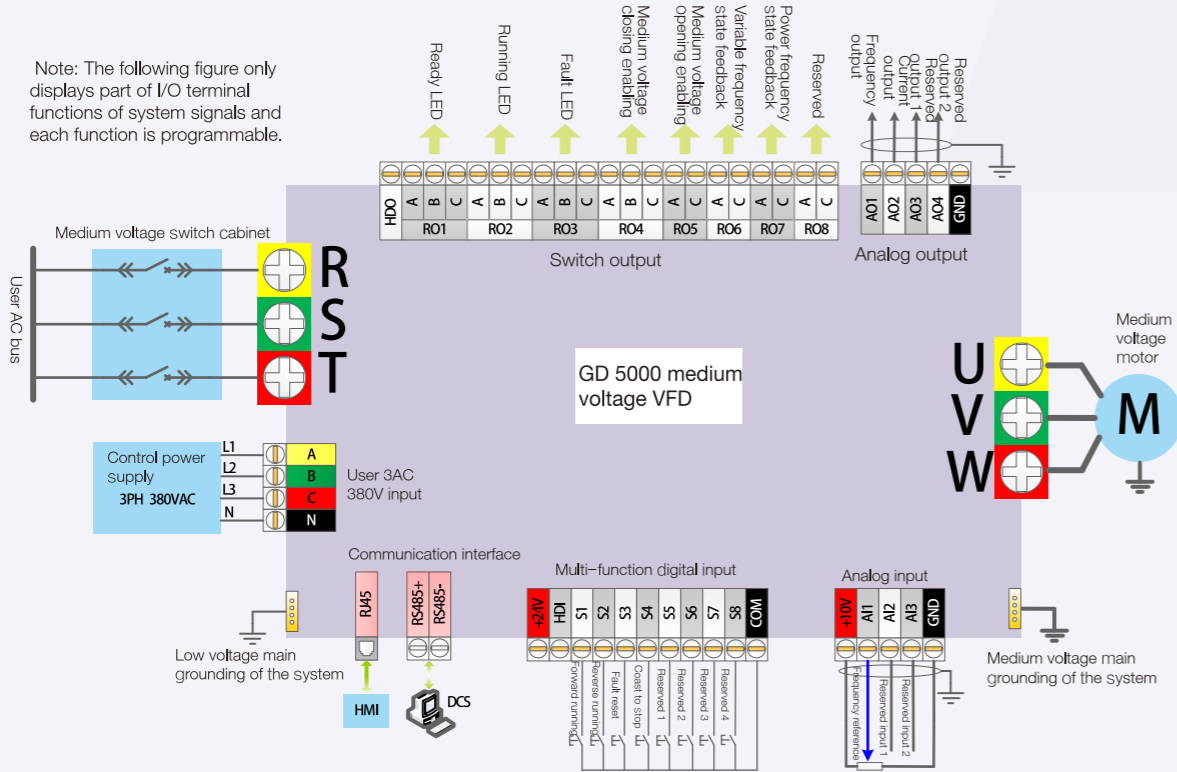

Two-quadrant topology

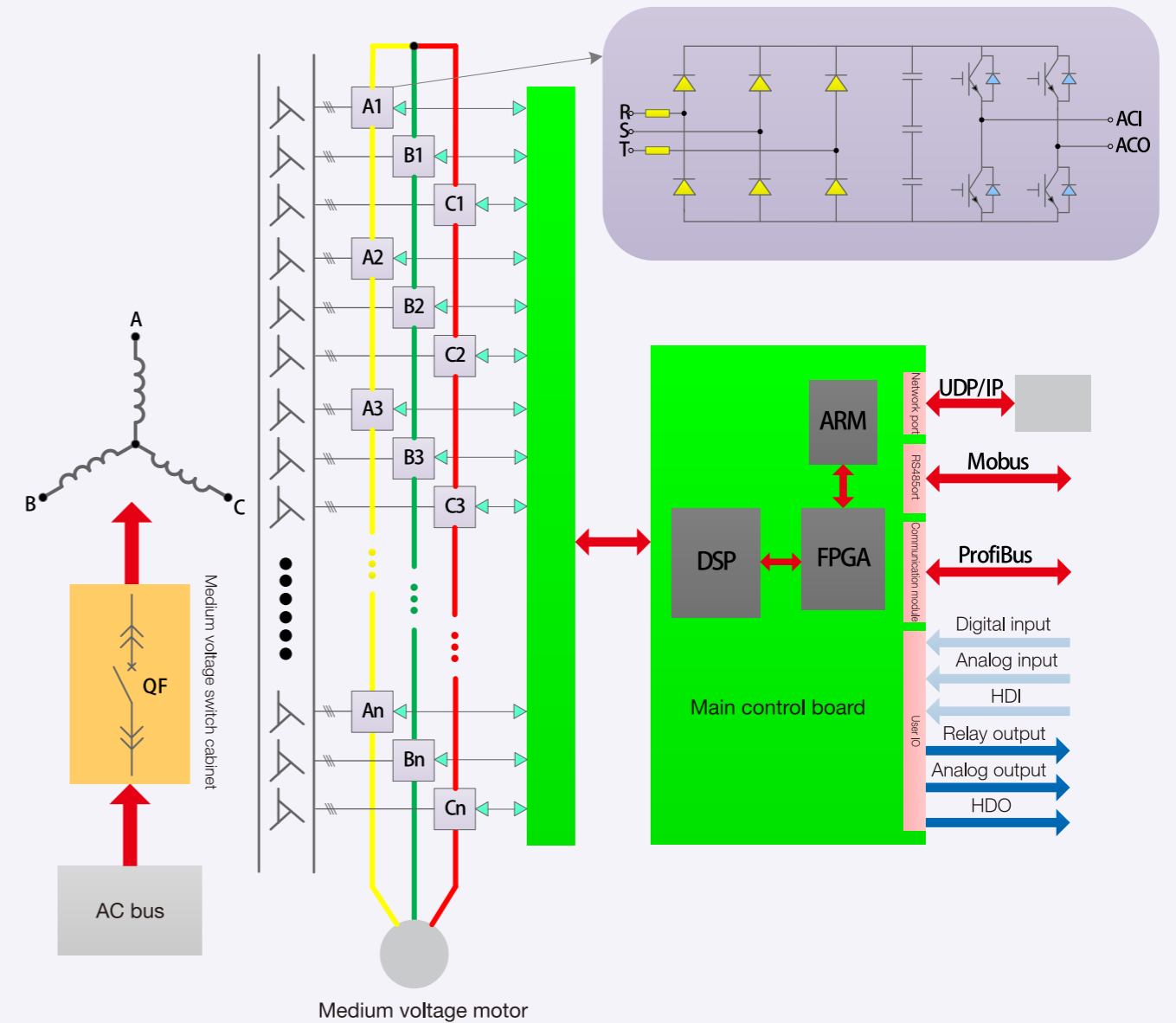

Model instruction

GD5000-A□□□□-□□-X X X X

① ② ③ ④ ⑤ ⑥ ⑦ ⑧

①	Name of medium voltage series products	GD 5000: high performance medium voltage VFD	⑤	Lot No.	D: dual-side maintenance S: front maintenance L: integrated machine
②	Product type	A: asynchronous vector product (AM) B: synchronous vector product (SM)	⑥	Lot No.	R: energy feedback system X: if no, default
③	Rated capacity	0500:500kVA	⑦	Lot No.	C: bypass system with unit contactor X: if no, default
④	Voltage degree	03:3kV 3.3:3.3kV 4.16:4.16kV 06:6kV 6.6:6.6kV 10:10kV 11:11kV	⑧	Lot No.	Special lot No. for other industries depending on later specific conditions

For example: GD5000-A3150-06-D indicates GD5000 series high performance medium voltage VFD, vector control, drive asynchronous motor, rated capacity 3150kVA, dual-side maintenance and two-quadrant operation.

Two-quadrant selection table

3kV

VFD model	Rated power(kW)	Rated current(A)	VFD dimension(mm)	Standard weight (Kg)
GD5000-A0280-03	220	54	3200X1200X2720	2416
GD5000-A0315-03	250	61	3200X1200X2720	2466
GD5000-A0355-03	280	68	3200X1200X2720	2506
GD5000-A0400-03	315	77	3800X1200X2720	2731
GD5000-A0450-03	355	87	3800X1200X2720	2881
GD5000-A0500-03	400	96	3800X1200X2720	2961
GD5000-A0560-03	450	108	4000X1200X2720	3149
GD5000-A0630-03	500	121	4000X1200X2720	3299
GD5000-A0710-03	560	137	4000X1200X2720	3349
GD5000-A0800-03	630	154	4000X1200X2720	3549
GD5000-A0900-03	710	173	4000X1200X2720	3790
GD5000-A1000-03	800	192	4000X1200X2720	3890
GD5000-A1120-03	900	216	4000X1200X2720	4030
GD5000-A1250-03	1000	241	4000X1200X2720	4380
GD5000-A1400-03	1120	269	5000X1500X2820	5560
GD5000-A1600-03	1250	308	5000X1500X2820	5810
GD5000-A1800-03	1400	346	5400X1500X2820	6710
GD5000-A2000-03	1600	385	5400X1500X2820	7010
GD5000-A2240-03	1800	431	5800X1500X2820	7760
GD5000-A2500-03	2000	481	5800X1500X2820	8160
GD5000-A2800-03	2240	539	5800X1500X2820	8860

3.3kV

VFD model	Rated power(kW)	Rated current(A)	VFD dimension(mm)	Standard weight (Kg)
GD5000-A0280-3.3	220	49	3200X1200X2660	2283
GD5000-A0315-3.3	250	55	3200X1200X2720	2416
GD5000-A0355-3.3	280	62	3200X1200X2720	2466
GD5000-A0400-3.3	315	70	3200X1200X2720	2506
GD5000-A0450-3.3	355	79	3800X1200X2720	2731
GD5000-A0500-3.3	400	87	3800X1200X2720	2881
GD5000-A0560-3.3	450	98	3800X1200X2720	2961
GD5000-A0630-3.3	500	110	4000X1200X2720	3149
GD5000-A0710-3.3	560	124	4000X1200X2720	3299
GD5000-A0800-3.3	630	140	4000X1200X2720	3349
GD5000-A0900-3.3	710	157	4000X1200X2720	3549
GD5000-A1000-3.3	800	175	4000X1200X2720	3790
GD5000-A1120-3.3	900	196	4000X1200X2720	3890
GD5000-A1250-3.3	1000	219	4000X1200X2720	4030
GD5000-A1400-3.3	1120	245	4000X1200X2720	4380
GD5000-A1600-3.3	1250	280	5000X1500X2820	5560
GD5000-A1800-3.3	1400	315	5000X1500X2820	5810
GD5000-A2000-3.3	1600	350	5400X1500X2820	6710
GD5000-A2240-3.3	1800	392	5400X1500X2820	7010
GD5000-A2500-3.3	2000	437	5800X1500X2820	7760
GD5000-A2800-3.3	2240	490	5800X1500X2820	8160
GD5000-A3150-3.3	2500	551	5800X1500X2820	8860

4.16kV

VFD model	Rated power(kW)	Rated current(A)	VFD dimension(mm)	Standard weight (Kg)
GD5000-A0315-4.16	250	44	3600X1200X2720	3405
GD5000-A0355-4.16	280	49	3600X1200X2720	3455
GD5000-A0400-4.16	315	56	3600X1200X2720	3638
GD5000-A0450-4.16	355	62	3600X1200X2720	3718
GD5000-A0500-4.16	400	69	3600X1200X2720	3798
GD5000-A0560-4.16	450	78	4200X1200X2720	4053
GD5000-A0630-4.16	500	87	4200X1200X2720	4353
GD5000-A0710-4.16	560	99	4200X1200X2720	4483
GD5000-A0800-4.16	630	111	4600X1200X2720	4743
GD5000-A0900-4.16	710	125	4600X1200X2720	5093
GD5000-A1000-4.16	800	139	4600X1200X2720	5243
GD5000-A1120-4.16	900	155	4600X1200X2720	5593
GD5000-A1250-4.16	1000	173	4600X1200X2720	5975
GD5000-A1400-4.16	1120	194	4600X1200X2720	6425
GD5000-A1600-4.16	1250	222	4600X1200X2720	6865
GD5000-A1800-4.16	1400	250	4600X1200X2720	7515
GD5000-A2000-4.16	1600	278	5000X1500X2820	8910
GD5000-A2240-4.16	1800	311	5000X1500X2820	9410
GD5000-A2500-4.16	2000	347	5400X1500X2820	10860
GD5000-A2800-4.16	2240	389	5400X1500X2820	11510
GD5000-A3150-4.16	2500	437	5800X1500X2820	13210
GD5000-A3550-4.16	2800	493	5800X1500X2820	14110
GD5000-A4000-4.16	3150	555	5800X1500X2820	15010

6kV

VFD model	Rated power(kW)	Rated current(A)	VFD dimension(mm)	Standard weight (Kg)
GD5000-A0400-06	315	38	2600X1500X2720	2644
GD5000-A0500-06	400	48	2600X1500X2720	2809
GD5000-A0560-06	450	54	2600X1500X2720	2886
GD5000-A0630-06	500	61	2600X1500X2720	2963
GD5000-A0710-06	560	68	2600X1500X2720	3177
GD5000-A0800-06	630	77	2600X1500X2720	3221
GD5000-A0900-06	710	87	2600X1500X2720	3342
GD5000-A1000-06	800	96	2600X1500X2720	3452
GD5000-A0400-06	315	38	3800X1200X2660	2965
GD5000-A0500-06	400	48	3800X1200X2660	3035
GD5000-A0560-06	450	54	3800X1200X2660	3170
GD5000-A0630-06	500	61	3800X1200X2660	3320
GD5000-A0710-06	560	68	3800X1200X2660	3370
GD5000-A0800-06	630	77	4400X1200X2660	3635
GD5000-A0900-06	710	87	4400X1200X2660	3785
GD5000-A1000-06	800	96	4400X1200X2660	3885
GD5000-A1120-06	900	108	4800X1200X2720	4268
GD5000-A1250-06	1000	120	4800X1200X2660	4408
GD5000-A1400-06	1120	135	4800X1200X2660	4758
GD5000-A1600-06	1250	154	4800X1200X2660	5058
GD5000-A1800-06	1400	173	4800X1200X2720	5610
GD5000-A2000-06	1600	192	4800X1200X2720	5810
GD5000-A2240-06	1800	216	4800X1200X2720	6060
GD5000-A2500-06	2000	241	4800X1200X2720	6560
GD5000-A2800-06	2240	269	5800X1500X2820	7550
GD5000-A3150-06	2500	303	5800X1500X2820	8350
GD5000-A3550-06	2800	342	6400X1500X2820	9750
GD5000-A4000-06	3150	385	6800X1500X2820	10000
GD5000-A4500-06	3550	433	7400X1500X2820	11600
GD5000-A5000-06	4000	481	7400X1500X2820	12000
GD5000-A5600-06	4500	539	7600X1500X2820	13180

Two-quadrant selection table

6.6kV

VFD model	Rated power(kW)	Rated current(A)	VFD dimension(mm)	Standard weight (Kg)
GD5000-A0400-6.6	315	35	4000X1200X2720	3026
GD5000-A0450-6.6	355	39	4000X1200X2720	3056
GD5000-A0500-6.6	400	44	4000X1200X2720	3096
GD5000-A0560-6.6	450	49	4000X1200X2720	3126
GD5000-A0630-6.6	500	55	4000X1200X2720	3402
GD5000-A0710-6.6	560	62	4000X1200X2720	3482
GD5000-A0800-6.6	630	70	4000X1200X2720	3552
GD5000-A0900-6.6	710	79	4600X1200X2720	3917
GD5000-A1000-6.6	800	87	4600X1200X2720	4017
GD5000-A1120-6.6	900	98	4600X1200X2720	4117
GD5000-A1250-6.6	1000	109	5000X1200X2660	4522
GD5000-A1400-6.6	1120	122	5000X1200X2660	4872
GD5000-A1600-6.6	1250	140	5000X1200X2660	5172
GD5000-A1800-6.6	1400	157	5000X1200X2660	5472
GD5000-A2000-6.6	1600	175	5000X1200X2720	5965
GD5000-A2240-6.6	1800	196	5000X1200X2720	6215
GD5000-A2500-6.6	2000	219	5000X1200X2720	6765
GD5000-A2800-6.6	2240	245	5000X1200X2720	7065
GD5000-A3150-6.6	2500	276	5800X1500X2820	8425
GD5000-A3550-6.6	2800	311	5800X1500X2820	8725
GD5000-A4000-6.6	3150	350	6800X1500X2820	9625
GD5000-A4500-6.6	3550	394	6800X1500X2820	10825
GD5000-A5000-6.6	4000	437	7400X1500X2820	12975
GD5000-A5600-6.6	4500	490	7600X1500X2820	13755
GD5000-A6300-6.6	5000	551	7600X1500X2820	14555

10kV

VFD model	Rated power(kW)	Rated current(A)	VFD dimension(mm)	Standard weight (Kg)
GD5000-A0500-10	400	29	2600X1500X2720	3195
GD5000-A0560-10	450	32	2600X1500X2720	3360
GD5000-A0710-10	560	41	2600X1500X2720	3514
GD5000-A0800-10	630	46	2600X1500X2720	3756
GD5000-A0900-10	710	52	2600X1500X2720	3877
GD5000-A1000-10	800	58	2600X1500X2720	4009
GD5000-A1120-10	900	65	2600X1500X2720	4284
GD5000-A1250-10	1000	72	2600X1500X2720	4361
GD5000-A1400-10	1120	81	2600X1500X2720	4526
GD5000-A1600-10	1250	92	2600X1500X2720	4724
GD5000-A1700-10	1400	98	2600X1500X2720	4856
GD5000-A0500-10	400	29	4600X1200X2660	3550
GD5000-A0560-10	450	32	4600X1200X2660	3550
GD5000-A0710-10	560	41	4800X1200X2660	3960
GD5000-A0800-10	630	46	4800X1200X2720	4070
GD5000-A0900-10	710	52	4800X1200X2720	4366
GD5000-A1000-10	800	58	4800X1200X2660	4426
GD5000-A1120-10	900	65	4800X1200X2660	4776
GD5000-A1250-10	1000	72	4800X1200X2660	4976
GD5000-A1400-10	1120	81	5200X1200X2720	5271
GD5000-A1600-10	1250	92	5200X1200X2720	5421
GD5000-A1700-10	1400	98	5200X1200X2720	5621
GD5000-A2000-10	1600	115	5800X1200X2720	6481
GD5000-A2240-10	1800	129	6200X1500X2720	6876
GD5000-A2500-10	2000	144	6200X1500X2720	7276
GD5000-A2800-10	2240	162	6200X1500X2720	7576
GD5000-A3150-10	2500	182	6200X1500X2720	8210
GD5000-A3550-10	2800	205	6200X1500X2720	9310
GD5000-A4000-10	3150	231	6200X1500X2720	10030
GD5000-A4500-10	3550	260	7000X1500X2820	10960
GD5000-A5000-10	4000	289	7000X1500X2820	11260
GD5000-A5600-10	4500	323	7200X1500X2820	11940
GD5000-A6300-10	5000	364	8000X1500X2820	14340
GD5000-A7100-10	5600	410	8800X1500X2820	15990
GD5000-A7500-10	6000	433	11200X1500X2820	19880
GD5000-A8000-10	6300	462	11200X1500X2820	21080
GD5000-A9000-10	7100	520	11200X1500X2820	22280
GD5000-A10000-10	8000	577	11200X1500X2820	23080

Two-quadrant selection table

11kV				
VFD model	Rated power(kW)	Rated current(A)	VFD dimension(mm)	Standard weight (Kg)
GD5000-A0500-11	400	26	4800X1200X2720	3699
GD5000-A0560-11	450	29	4800X1200X2720	3749
GD5000-A0630-11	500	33	4800X1200X2720	3849
GD5000-A0710-11	560	37	5000X1200X2720	4129
GD5000-A0800-11	630	42	5000X1200X2720	4179
GD5000-A0900-11	710	47	5000X1200X2720	4279
GD5000-A1000-11	800	52	5000X1200X2660	4608
GD5000-A1120-11	900	59	5000X1200X2660	4918
GD5000-A1250-11	1000	66	5000X1200X2660	5118
GD5000-A1400-11	1120	73	5000X1200X2660	5368
GD5000-A1600-11	1250	84	5400X1200X2720	5503
GD5000-A1800-11	1400	94	5400X1200X2720	5843
GD5000-A2000-11	1600	105	6000X1200X2720	6376
GD5000-A2240-11	1800	118	6000X1200X2720	6826
GD5000-A2500-11	2000	131	6400X1200X2720	7421
GD5000-A2800-11	2240	147	6400X1200X2720	7671
GD5000-A3150-11	2500	165	6400X1200X2720	7871
GD5000-A3550-11	2800	186	6400X1200X2720	9395
GD5000-A4000-11	3150	210	6400X1200X2720	10295
GD5000-A4500-11	3550	236	6400X1200X2720	10595
GD5000-A5000-11	4000	262	7800X1500X2820	12005
GD5000-A5600-11	4500	294	8000X1500X2820	14385
GD5000-A6300-11	5000	331	9000X1500X2820	16885
GD5000-A7000-11	5600	367	9000X1500X2820	17585
GD5000-A8000-11	6300	420	12600X1500X2820	21765
GD5000-A9000-11	7100	472	12600X1500X2820	23265
GD5000-A10000-11	8000	525	12600X1500X2820	25665

Four-quadrant topology

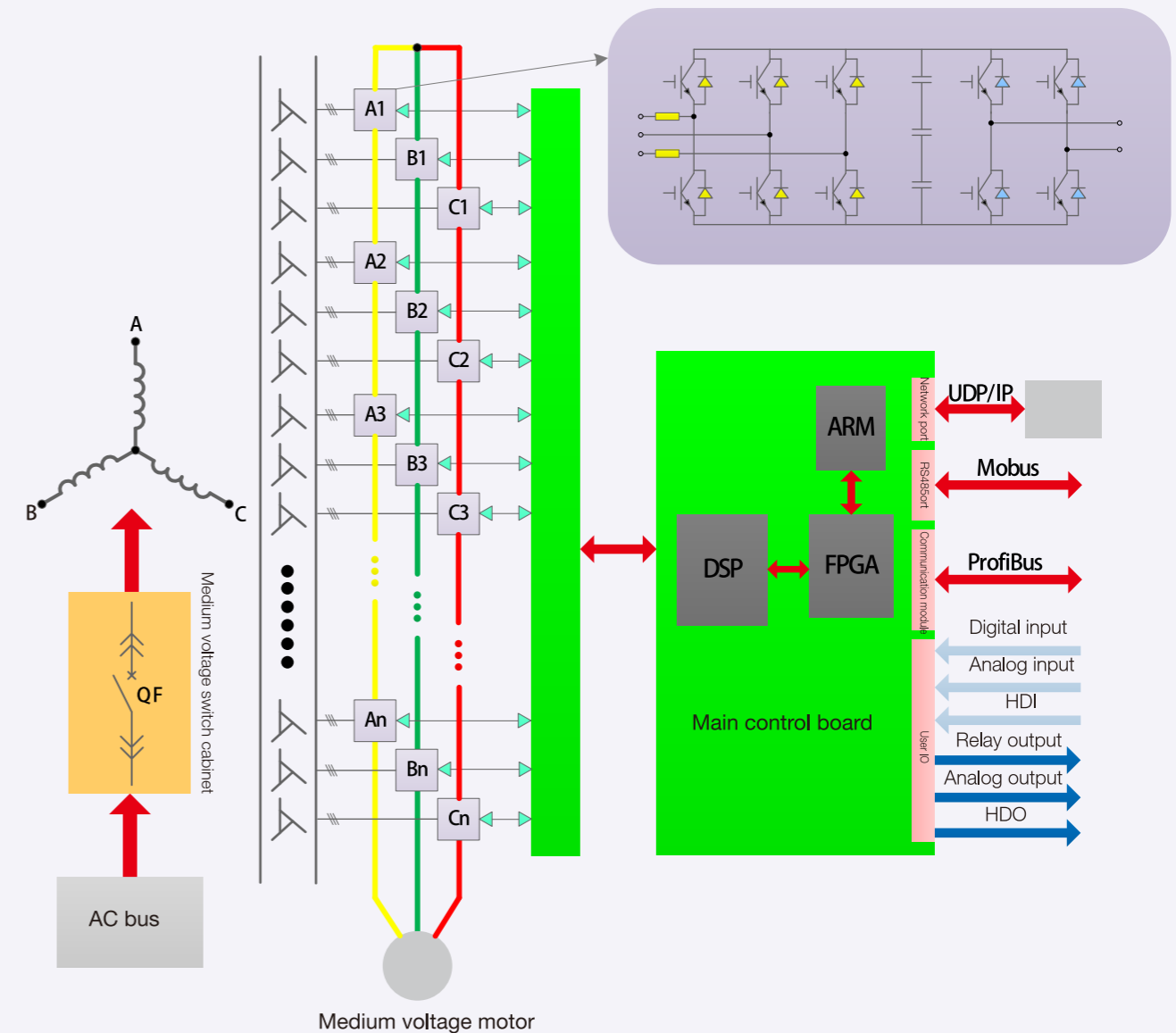

Four-quadrant selection table

6kV

VFD model	Rated power(kW)	Rated current(A)	VFD dimension(mm)	Standard weight (Kg)
GD5000-A0315-06	250	30	4400X1200X2660	3190
GD5000-A0355-06	280	34	4400X1200X2660	3240
GD5000-A0400-06	315	38	4400X1200X2660	3370
GD5000-A0450-06	355	43	4400X1200X2660	3420
GD5000-A0500-06	400	48	4400X1200X2660	3470
GD5000-A0560-06	450	54	4400X1200X2660	3520
GD5000-A0630-06	500	61	4800X1200X2660	3890
GD5000-A0710-06	560	68	4800X1200X2660	3990
GD5000-A0800-06	630	77	4800X1200X2660	4090
GD5000-A0900-06	710	87	4800X1200X2660	4290
GD5000-A1000-06	800	96	4800X1200X2660	4540
GD5000-A1120-06	900	108	4800X1200X2720	4755
GD5000-A1250-06	1000	120	4800X1200X2720	4945
GD5000-A1400-06	1120	135	4800X1200X2720	5145
GD5000-A1600-06	1250	154	4800X1200X2720	5345

10kV

VFD model	Rated power(kW)	Rated current(A)	VFD dimension(mm)	Standard weight (Kg)
GD5000-A0400-10	315	23	5200X1200X2660	3877
GD5000-A0450-10	355	26	5200X1200X2660	3927
GD5000-A0500-10	400	29	5200X1200X2660	4057
GD5000-A0560-10	450	32	5200X1200X2660	4157
GD5000-A0630-10	500	36	5200X1200X2660	4207
GD5000-A0710-10	560	41	5200X1200X2660	4357
GD5000-A0800-10	630	46	5200X1200X2720	4547
GD5000-A0900-10	710	52	5200X1200X2720	4747
GD5000-A1000-10	800	58	5800X1200X2660	5261
GD5000-A1120-10	900	65	5800X1200X2660	5411
GD5000-A1250-10	1000	72	5800X1200X2660	5611
GD5000-A1400-10	1120	81	5800X1200X2720	5921
GD5000-A1600-10	1250	92	5800X1200X2720	6221
GD5000-A1700-10	1400	98	5800X1200X2720	6321
GD5000-A2000-10	1600	115	5800X1200X2720	6997
GD5000-A2240-10	1800	129	6200X1500X2720	7392
GD5000-A2500-10	2000	144	6200X1500X2720	7792

List of options and parts

Name	Model	Picture	Description
Communication card	AB4005		Support Profibus-DP protocol
PG card	EC-PG103		Encoder interface, support push-pull encoder A, B, Z signal input, differential, push-pull and open collector output
Contactors	GSZ2		Used for unit mechanical bypass
Bumpless switching cabinet	GD5000-SS		Embedded with reactors, used for synchronous bumpless switching between power frequency and variable frequency
Bypass cabinet	GD5000-AS GD5000-MS		Manual bypass cabinet: 3 isolated switches; Isolating automatic bypass cabinet: 2 isolated switches and 3 vacuum contactors; Can select different bypass solutions according to on-site conditions.
Remote operation cabinet	GD5000-CB		Used for on-site remote control, the button functions and the displayed parameters can be customized
Upper computer monitoring software	INVT STUDIO		Obtain the control of the upper computer on the VFD, possess the functions of start and stop command, parameter read and write, fault diagnosis and oscilloscope Can meet non-standard requirements by modifying relative configuration

Domestic applications

Power industry

Application of GD5000 series in the feed water pump of circulating fluidized bed boiler

1 Project background

One thermoelectric center of Sinopec has a 300MW coal-fired power generating set whose feed water pump of the bed boiler is driven by a 6kV/2240kW asynchronous motor. During production, the water pump runs in power frequency and the flow is adjusted by the outlet valve of the water pump, causing great energy waste, severe wind board wear and large noise.



3 Other applications



2*600M set



Shenhua Group 2*300M set



Guadian Qingshan Thermal Power Plant 2*350M set

Domestic applications

Metallurgy

Application of GD5000 series in the large power synchronous motor

1 Project background

One company of Hebei Iron&Steel Group has two 200m² sintering machines whose main sintering fan is driven by a 10kV/ 7100kW synchronous motor. At beginning, the water resistance cabinet is used to start the motor. During starting, once the excitation system is under inaccurate control, the motor will be out of step and cannot start. Additionally, the wind boards are used to adjust air flow, causing great energy waste.

2 Schematic diagram of scheme

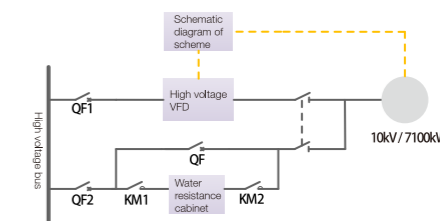

3 Result after improvement

The excellent synchronous motor control technology of GD5000 products solves the out-of-step problem of the synchronous motor; obvious energy saving effect, up to 26% electricity saving rate

4 Other applications



Domestic applications

Metallurgy

Application of GD5000 series in the sweetening fan

1 Project background

Yunnan Copper Group establishes a set of sweetening system whose induced draft fan is driven by a 6kV/800kW motor. The load plays an important part in production. Once it goes wrong, environmental pollution will be caused. Furthermore, there are a lot of particles and dust on site, putting a high requirement on corrosion resistance.

2 Product feature

The dual-layer conformal coating technology ensures corrosion resistance capability of the components and plates



Domestic applications

Building industry

Application of GD5000 series at high altitude

1 Project background

One building materials company in Tibet is located at over 3700km high altitude. The high temperature fan at furnace end is driven by 10kV/2800kW asynchronous motor. Due to frequent material collapse, the production cannot be continuous.

2 Product feature

The design of high altitude components ensures the VFD meets the safety requirements at high altitude; Excellent speed and strong overload capability ensures continuous production during material collapse.



3 Other applications

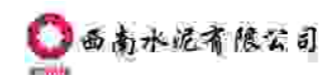

Domestic applications

Chemical industry

Application of GD5000 series in the centrifugal compressor

1 Project background

One petrochemical company in Shangdong mainly involving in petroleum refining is one of China's top 500 companies. The circulating gas compressor in the propylene production workshop belongs to heavy load, causing large starting impulse current, large noise and sudden changes in pressure. Furthermore, because the load has large fluctuation, adjusting the pressure only by the opening of the valve will cause great energy waste.

2 On-site pictures



3 Main advantages

Excellent low frequency control feature satisfies heavy-load start of the compressor on site, the average running current of the motor reduces greatly and the energy saving benefit is obvious.

Parameters	Power frequency	Variable frequency
Running current	47A	7A
Rotating speed of the motor	2980r/min	1200r/min
Power factor	0.47	0.95
Annual electricity saving cost	943,000 RMB each machine	

Domestic applications

Chemical industry

Application of GD5000 series in the induced draft fan

1 Project background

In a new urea plant project of one coal chemical company of Jincheng Anthracite Mining Group, 8 induced draft fans and 1 feed water pump of the boiler system use our medium voltage VFD. Since put into operation, the VFD has been in stable running, received good economic benefits and high praise from customers.

2 On-site pictures

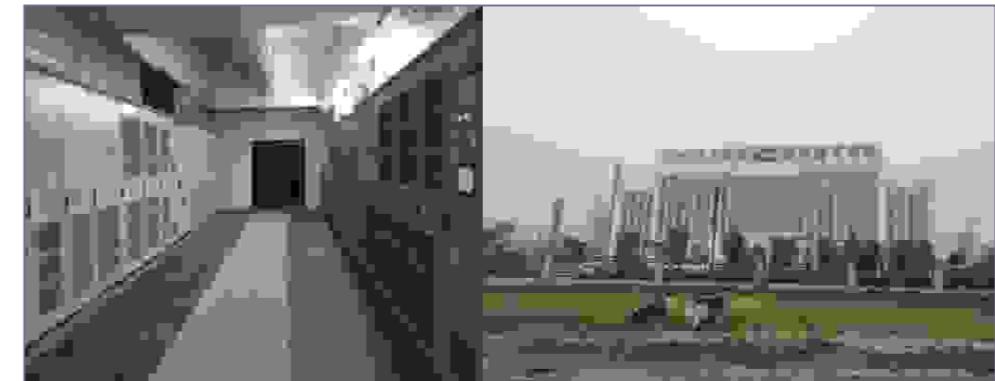

Application of GD5000 series in the gas pressure blower

1 Project background

For the gas pressure blower of one chemical fertilizer enterprise in Anhui, the roots blower is driven by one 6kV/560kW 10-pole motor. Before improvement, the large starting current has a bad effect on the devices in the same bus and adjusting the air flow by return valve will cause great energy waste.

2 On-site pictures

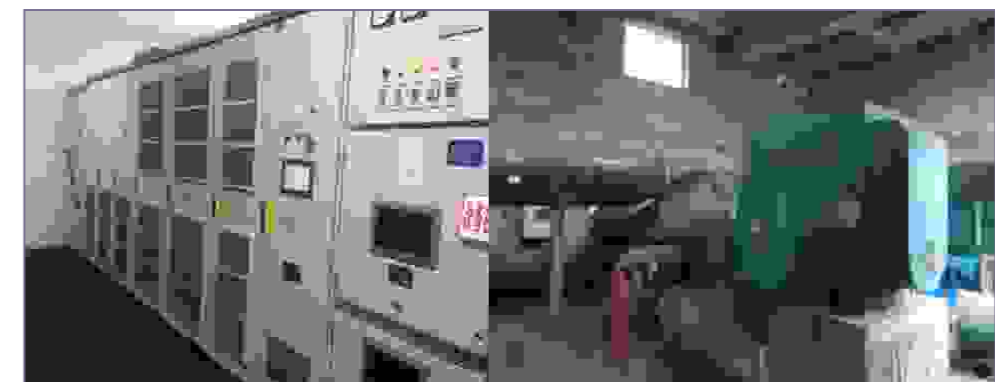

Domestic applications

Mine industry

Application of GD5000 series in the main fan

1 Project background

The contra-rotating fan for ventilation in one mine of Meijin Energy Group is driven by two 10kV/900kW asynchronous motors at power frequency and constant speed. Its air flow is adjusted by wind board manually, causing great energy waste and having bad effect on production.

2 Schematic diagram of scheme

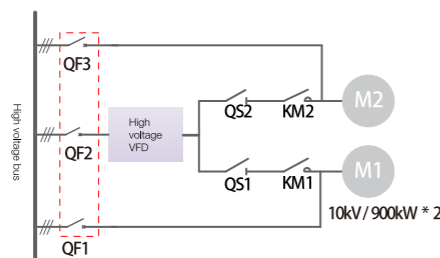

3 Main advantages

Obvious energy saving, electricity saving rate up to 30%;
One-drive-two structure, downsizing the devices

Domestic applications

Mine industry

Application of GD5000 series in the belt conveyor

1 Project background

The annual coal yield of Jincheng Anthracite Mining Group is 0.6 million tons. The belt conveyor at the outlet of the mine is driven by two motors. The company adopts soft starter and hydraulic coupler for the start and speed regulation of motors, which comes about a lot of disadvantages. The soft starter may generate a great deal of harmonic, the hydraulic coupler may easily have faults, there is heavy maintenance workload and the hydraulic coupling cannot solve the problem of power balance among motors during multi-motor drive.

2 Schematic diagram of scheme

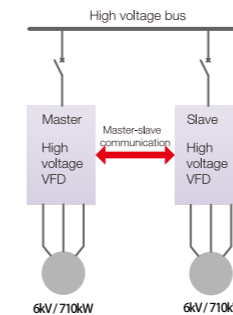

3 Main advantages

Master-slave control achieves power balance between two motors;
Excellent low frequency control feature satisfies heavy-load start of the belt conveyor

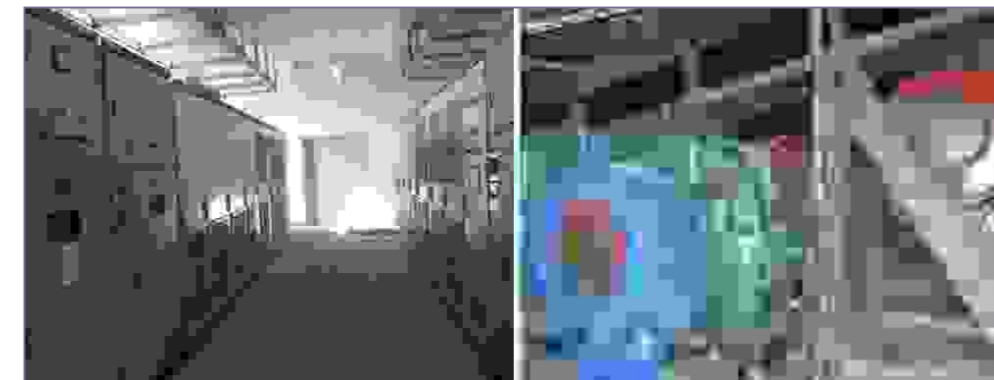

Domestic applications

Mine industry

Application of GD5000 series in the underground drainage pump

1 Project background

The underground equipment of Guizhou Zijin Mining Group is supplied power by generator. The capacity of the grid is small. To reduce the starting current, adopt the stator reactor starting whose result is not satisfactory. Furthermore, someone is needed on duty the whole day to start and stop the motor on site when the water level changes, so the labor intensity is increased.

2 On-site pictures



3 Main advantages

The design of split-type structure and underground installation facilitate maintenance;
The soft start and stop of the motor and small starting current totally satisfy the working conditions

Domestic applications

Mine industry

Application of GD5000 series in the roller press

1 Project background

The moving roller and fixed roller of one tungsten ore factory in Fujian are separately driven by two 10kV/630kW motors. In current, almost all roller presses are running in constant frequency, so the yield cannot be adjusted, overcurrent may occur to the moving roller and fixed roller due to unbalance power and the production will be affected.

2 Schematic diagram of scheme

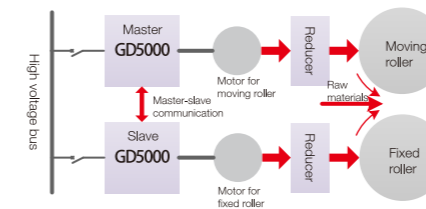

3 Main advantages

Master-slave control achieves power balance between the moving and fixed rollers and improves the stability of the system;
Excellent low frequency control feature satisfies heavy-load start of the roller press



Domestic applications

Oil and gas industry

Application of GD5000 series in the water injection pump

1 Project background

As well known, the water injection pump consumes large part of electricity in the oil industry and the water injection of each area needs to be adjusted usually when the exploitation conditions change. The water injection pump in one well of Jiangsu Oil Field adopts return valve to control the flow, causing serious energy waste and mined out. After improvement, not only does the water injection pump become energy saving, but also the process improves greatly.

2 On-site pictures



Domestic applications

Municipal industry

Application of GD5000 series in the pumping station

1 Project background

One pumping station in Xinjiang is equipped with 4 centrifugal water pumps and common bus pipe separately driven by 10kV/1250kW asynchronous motors. After improvement, the process of the pumping station reaches the requirement of three in power frequency and one in variable frequency.

2 Schematic diagram of scheme

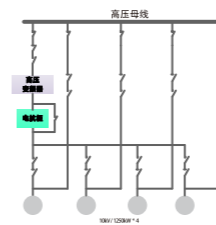

3 Main advantages

One-drive-four structure downsize the equipment significantly;
The motors can realize soft start in turn;
The VFD has bumpless synchronous switching function and no impact current when switching between power frequency and variable frequency.

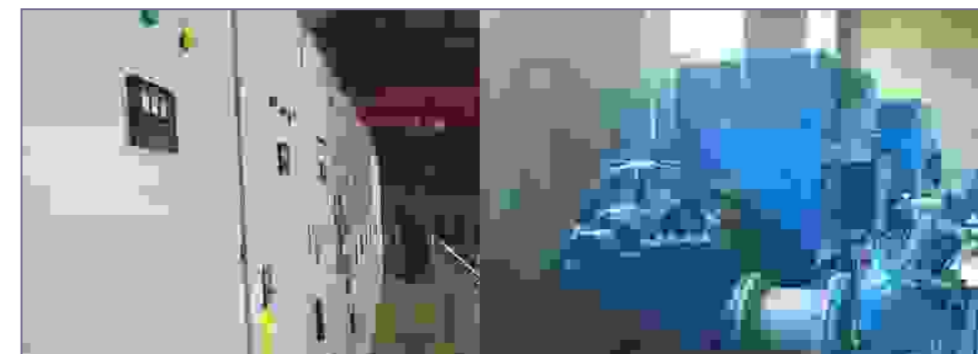

Application of GD5000 series in the secondary fan of thermal power station

1 Project background

The fan of the boiler system from one thermal power factory in Dongning in Heilongjiang keeps running in power frequency and the air flow is adjusted by wind board. In the practical production, the opening of the board is small, causing serious energy waste. After many aspects of investigation, the company chooses our VFDs for energy saving reconstruction.

2 On-site pictures

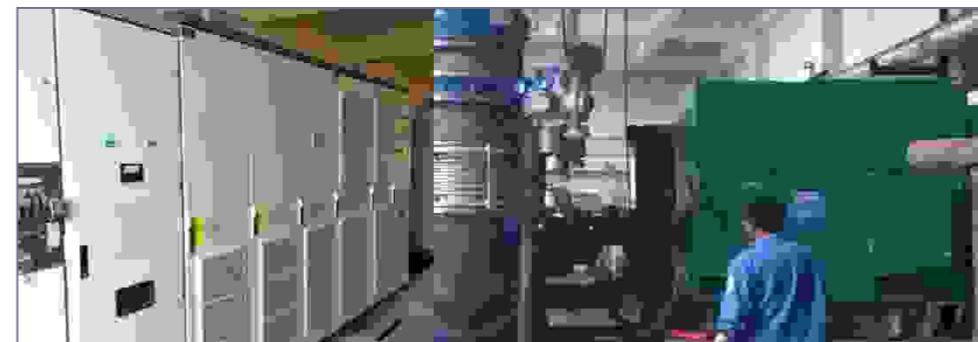



- ★ INVT Headquarters
- INVT Sales & Service in 13 countries
- Sales and Service Partners in 63 countries

